

# ART 715-A MK4

## ACTIVE TWO-WAY SPEAKER

### DESCRIPTION

ART 715-A MK4 is a unique product in its category. The professional compression driver with custom designed dome and high power voice coil offers unique vocal clarity and constant sound coverage. The 15" woofer offers an extremely linear response and a precise low frequency control. The transducers are produced using the most advanced assembly technologies. The two channel amplifier delivers 1400 watts and is controlled by a DSP that takes care of crossover, equalization, phase control, soft limiting and transducers protection.



### FEATURES

- 130 dB Max SPL
- Two Channel Amplifier of 1400 WATT
- Innovative DSP Processing
- 1" Compression Driver, 1.75" v.c.
- 15" Woofer
- 90°x60°, wide dispersion constant directivity horn
- FiRPHASE Technology

## TECHNICAL SPECIFICATIONS

<b>Acoustical specifications</b>	Frequency Response:	45 Hz ÷ 20000 Hz
	Max SPL @ 1m:	130 dB
	Horizontal coverage angle:	90°
	Vertical coverage angle:	60°
<b>Transducers</b>	Compression Driver:	1.0", 1.75" v.c
	Woofers:	15", 2.5" v.c
<b>Input/Output section</b>	Input signal:	bal/unbal
	Input connectors:	XRL, Jack
	Output connectors:	XLR
	Input sensitivity:	-2 dBu/+4 dBu
	Mic. Input Sensitivity:	-32 dBu
<b>Processor section</b>	Crossover Frequencies:	1600 Hz
	Protections:	Thermal, RMS
	Limiter:	Soft Limiter
	Controls:	Volume, Boost, Mic/Line
<b>Power section</b>	Total Power:	1400 W Peak, 700 W RMS
	High frequencies:	400 W Peak, 200 W RMS
	Low frequencies:	1000 W Peak, 500 W RMS
	Cooling:	Convection
	Connections:	VDE
<b>Standard compliance</b>	CE marking:	Yes
<b>Physical specifications</b>	Cabinet/Case Material:	PP Composite
	Hardware:	2 x M10
	Handles:	1 Top, 2 Side
	Pole mount/Cap:	Yes
	Grille:	Steel
	Color:	Black
<b>Size</b>	Height:	708 mm / 27.87 inches
	Width:	437 mm / 17.2 inches
	Depth:	389 mm / 15.31 inches
	Weight:	19.6 kg / 43.21 lbs
<b>Shipping informations</b>	Package Height:	750 mm / 29.53 inches
	Package Width:	500 mm / 19.69 inches
	Package Depth:	440 mm / 17.32 inches
	Package Weight:	23 kg / 50.71 lbs



**PART NUMBER**

• **13000525**

ART 715-A MK4

115V

EAN 8024530014841

• **13000524**

ART 715-A MK4

220-240V

EAN 8024530014971

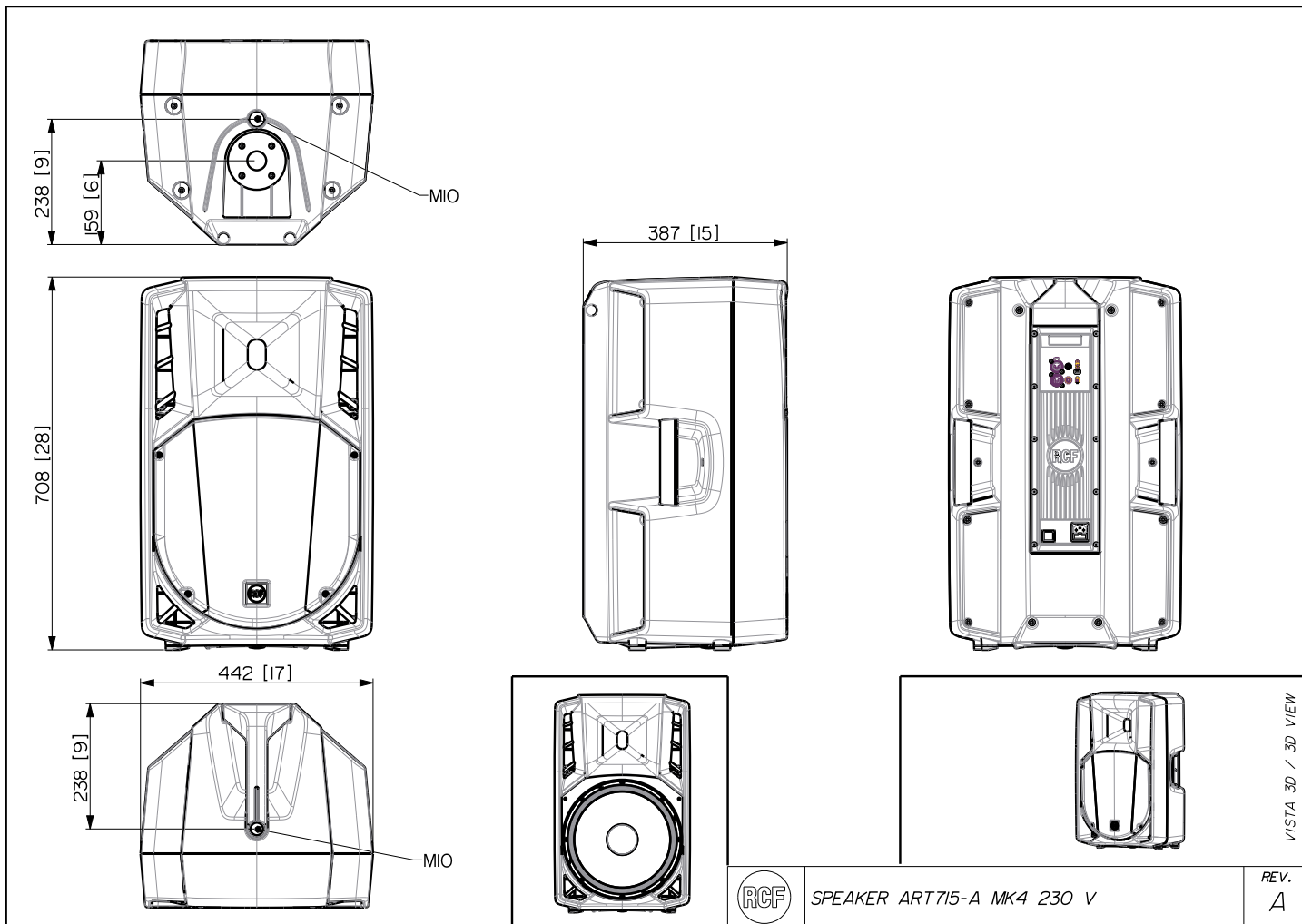

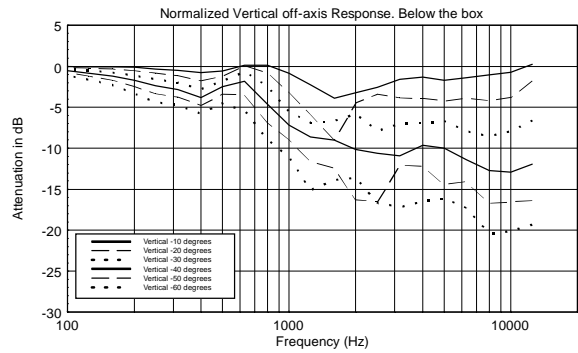
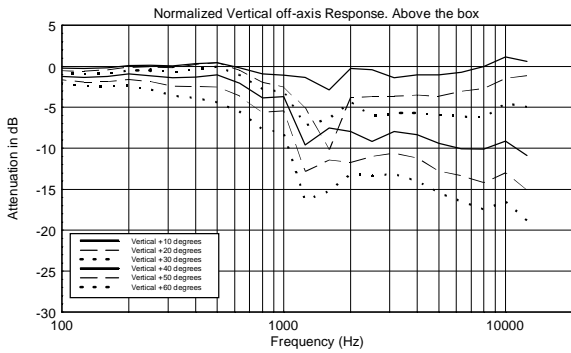
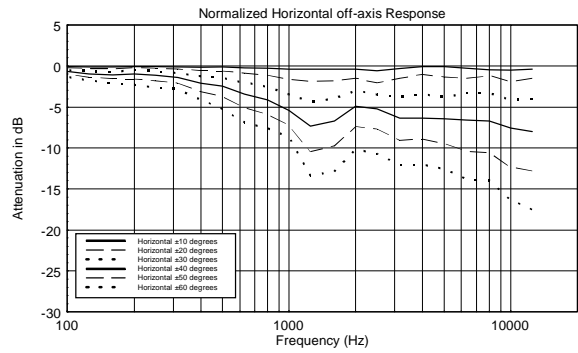
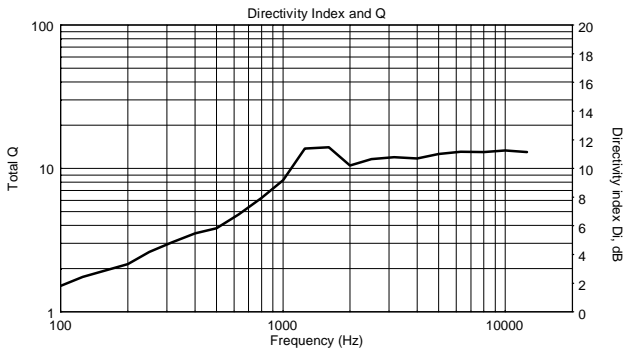
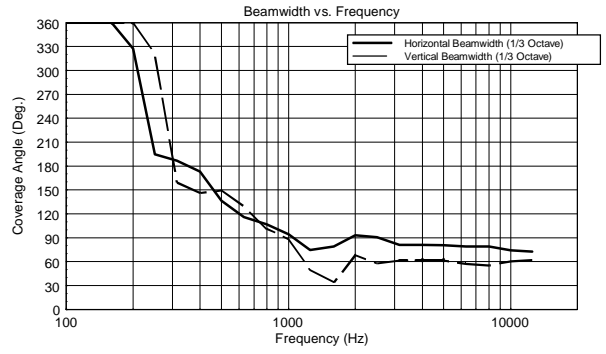
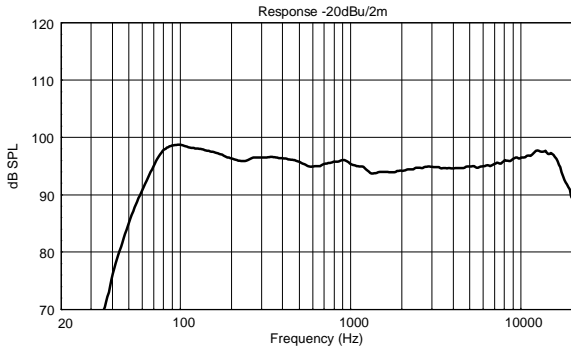

Horizontal 1/3 Octave Polars

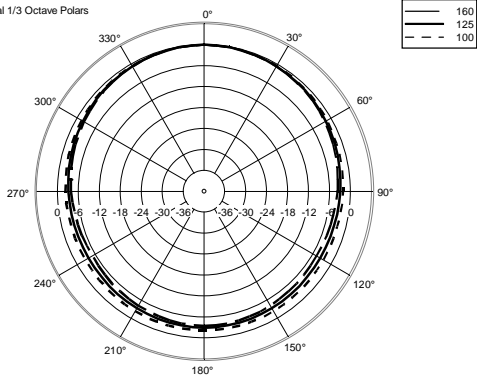

Horizontal 1/3 Octave Polars

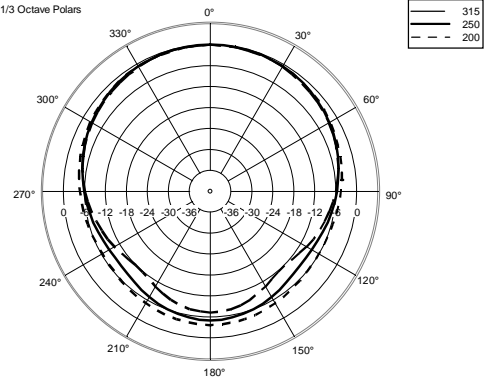

Horizontal 1/3 Octave Polars

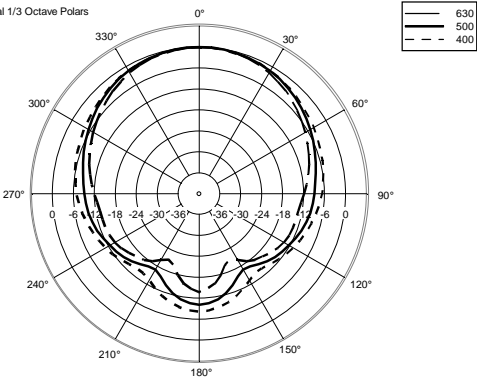

Horizontal 1/3 Octave Polars

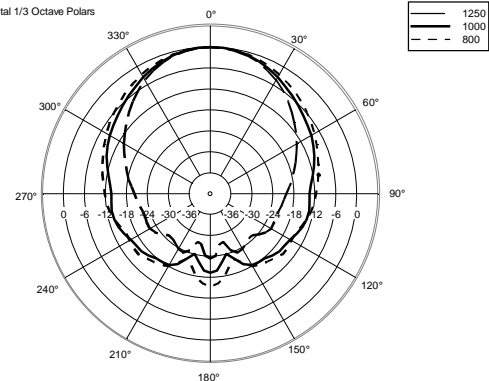

Horizontal 1/3 Octave Polars

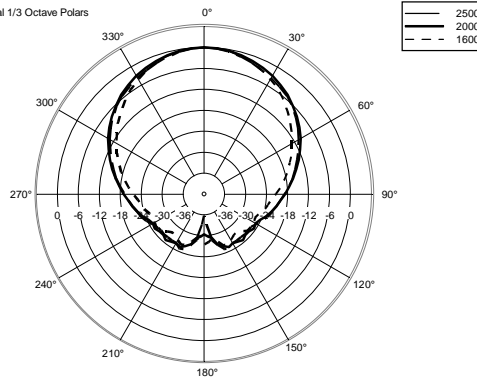

Horizontal 1/3 Octave Polars

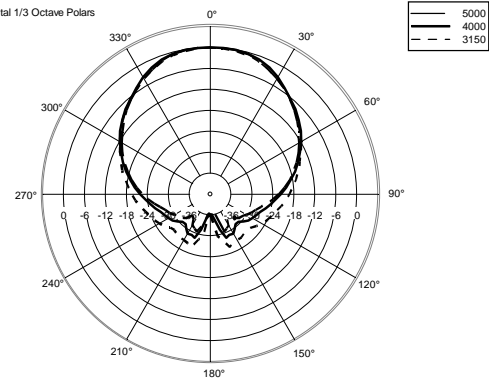

Horizontal 1/3 Octave Polars

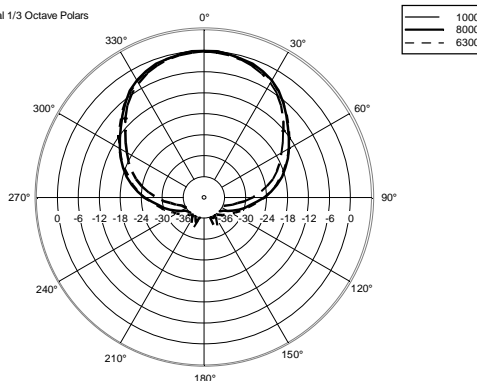

Horizontal One Octave Polars

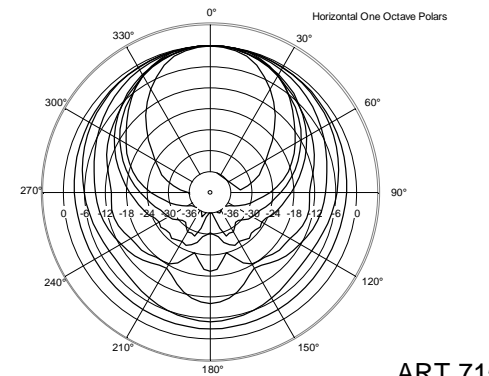

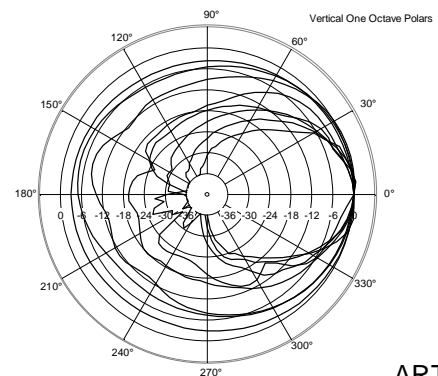
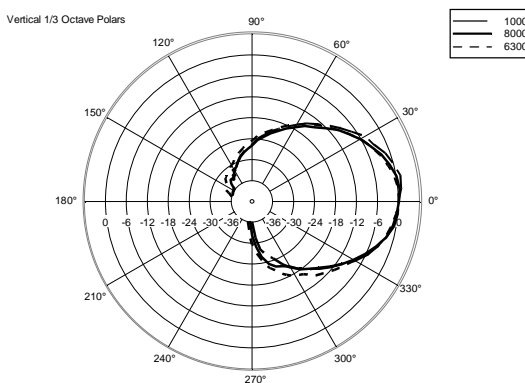
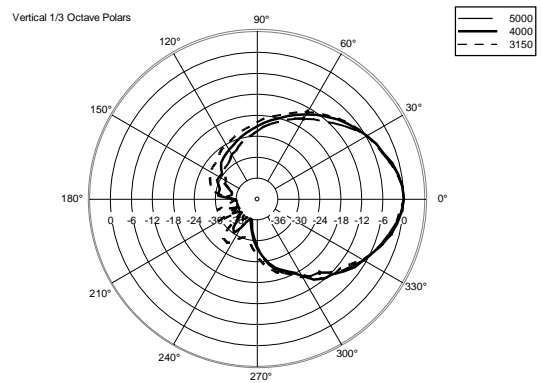
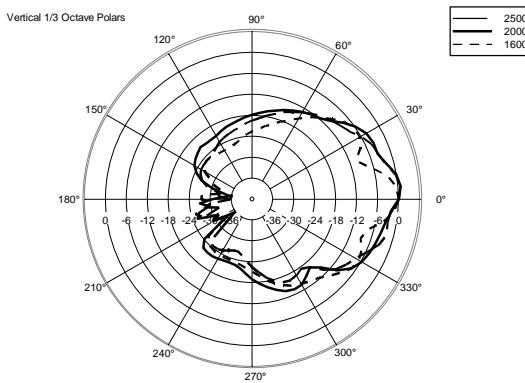
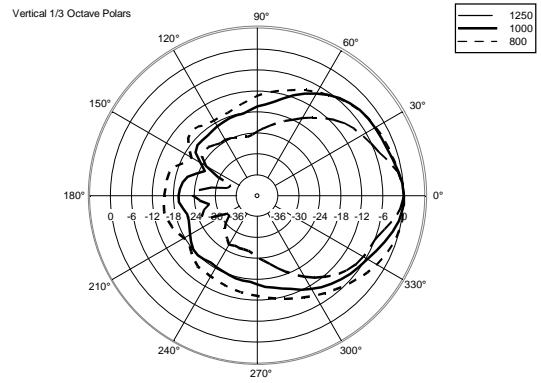
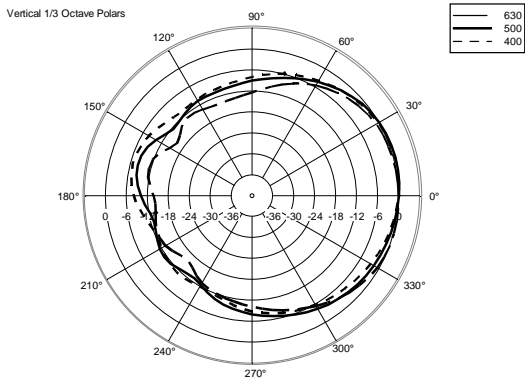
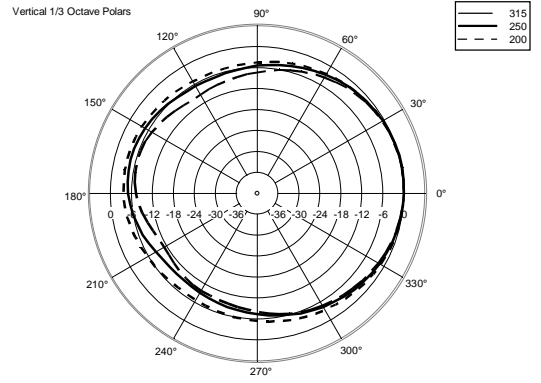
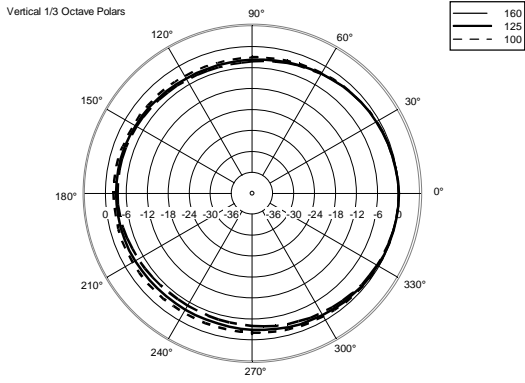

**ACCESSORIES**

AC PMA - POLE MOUNT

PART NUMBER **13360034**  
EAN: 8024530007713

AC PM-M20

PART NUMBER **13360067**  
EAN: 8024530014599

AC PMX POLE MOUNT M20

PART NUMBER **13360232**  
EAN: 8024530010058

AC PRO-FS PROFESS. LOCKING FLOOR STAND

PART NUMBER **13360109**  
EAN: 8024530006471

AC PRO-PM PROFESS. LOCKING POLE MOUNT

PART NUMBER **13360110**  
EAN: 8024530006488

COVER CVR ART 725

PART NUMBER **13360115**  
EAN: 8024530010676

HORIZONTAL BRACKET H-BR 2X ART 715

PART NUMBER **13360105**  
EAN: 8024530012939